

## Anodētie alumīnija profili

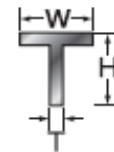
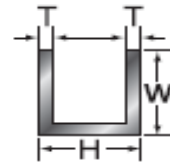
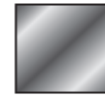

# ALUMĪNIJA PROFILI

## Speciālie profili

Profili ventilējamām fasādēm

## Anodētie alumīnija profili

Garums: 6000mm



Izmērs, mm	kg/m
15x15x2	0,16
20x20x2	0,21
25x25x2	0,26
30x30x2	0,32
40x40x2	0,43

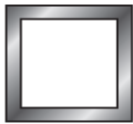

Izmērs, mm	kg/m
20x20x1	0,21
20x20x2	0,39
25x25x2	0,52
30x30x2	0,61
40x20x2	0,61
40x40x2	0,83
70x20x2	0,92

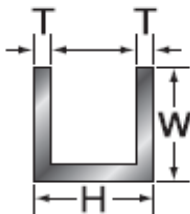

Izmērs, mm	kg/m
10x20x10x2	0,2
15x15x15x2	0,23
20x20x20x2	0,32
20x40x20x2	0,51
25x25x25x2	0,4
40x20x40x2	0,52
9.5x19.1x9.5x1.3	
20x19.1x20x1.3	



Izmērs, mm	kg/m
8x1	
12x1	
16x1.5	
25x1.5	0,3

Garums: 5000mm















# ARTRIAL



Sakausējumi

EN AW

6060-T6;  
6063-T6;  
6082-T6

Garums:6000mm

Izmērs, mm	kg/m	Izmērs, mm	kg/m	Izmērs, mm	kg/m	Izmērs, mm	kg/m	Izmērs, mm	kg/m
10x2	0,06	30x12	0,98	50x40	5,40	80x20	4,32	125x15	5,10
10x3	0,09	30x15	1,22	60x2	0,32	80x25	5,40	125x40	13,50
10x4	0,11	30x20	1,62	60x3	0,49	80x30	6,48	134x35	12,91
10x5	0,14	30x25	2,03	60x4	0,65	80x40	8,64	140x20	7,70
10x8	0,22	35x3	0,29	60x5	0,81	80x50	10,90	140x30	11,40
12x3	0,10	35x4	0,38	60x6	0,98	80x60	13,00	140x40	15,20
12x4	0,13	35x5	0,48	60x8	1,20	85x30	6,89	150x5	2,02
12x8	0,26	35x6	0,60	60x10	1,62	90x5	1,22	150x8	3,24
15x2	0,09	35x8	0,76	60x12	1,95	90x10	2,43	150x10	4,05
15x3	0,13	35x10	0,95	60x15	2,43	90x20	4,95	150x12	4,86
15x4	0,17	35x12	1,14	60x20	3,24	100x3	0,81	150x15	6,08
15x5	0,21	35x15	1,42	60x25	4,08	100x4	1,14	150x20	8,10
15x6	0,24	40x2	0,22	60x30	4,86	100x5	1,35	150x25	10,13
15x8	0,33	40x3	0,33	60x40	6,80	100x6	1,62	150x30	12,15
15x10	0,41	40x4	0,44	60x50	8,10	100x8	2,16	160x20	8,64
20x2	0,11	40x5	0,54	70x5	0,95	100x10	2,70	165x65	28,96
20x3	0,17	40x6	0,65	70x6	1,14	100x12	3,24	175x75	11,85
20x4	0,22	40x8	0,87	70x8	1,53	100x15	4,05	180x20	9,80
20x5	0,27	40x10	1,08	70x10	1,89	100x20	5,40	180x50	24,50
20x6	0,33	40x12	1,30	70x12	2,27	100x25	7,00	200x10	5,40
20x8	0,44	40x15	1,62	70x15	2,84	100x30	8,10	200x12	6,48
20x10	0,54	40x20	2,16	70x25	4,75	100x35	9,45	200x15	8,10
20x12	0,65	40x25	2,71	70x30	5,70	100x40	10,80	200x20	10,80
20x15	0,81	40x30	3,24	70x35	6,80	100x50	13,50	200x30	16,20
25x2	0,14	45x3	0,36	70x40	7,60	100x60	16,20	200x40	21,90
25x3	0,21	45x5	0,61	70x50	9,71	100x70	18,90	200x50	27,00
25x4	0,27	45x6	0,73	75x6	1,21	100x80	22,00	200x60	32,40
25x5	0,36	45x8	0,97	75x8	1,62	110x10	3,00	310x20	16,74
25x6	0,41	45x10	1,22	75x10	2,03	120x5	1,62	310x90	75,33
25x8	0,54	50x2	0,27	75x15	3,10	120x10	3,24		
25x10	0,68	50x3	0,41	75x20	4,15	120x12	3,89		
25x12	0,81	50x4	0,54	75x25	5,08	120x15	4,86		
25x15	1,02	50x5	0,68	75x40	8,10	120x20	6,50		
25x20	1,35	50x6	0,81	80x3	0,65	120x25	8,40		
30x2	0,17	50x8	1,08	80x4	0,87	120x30	9,72		
30x3	0,25	50x10	1,35	80x5	1,08	120x50	16,20		
30x4	0,33	50x12	1,62	80x6	1,3	120x60	19,50		
30x5	0,41	50x15	2,05	80x8	1,73	120x70	23,10		
30x6	0,49	50x20	2,7	80x10	2,16	120x80	26,00		
30x8	0,65	50x25	3,38	80x12	2,6	125x10	3,38		
30x10	0,81	50x30	4,05	80x15	3,24	125x12	4,05		

# ARTRIAL



Diametrs, mm	kg/m
3	0,02
4	0,04
5	0,06
6	0,08
7	0,11
8	0,15
9	0,19
10	0,22
12	0,33
13	0,38
14	0,44
15	0,50
16	0,58
17	0,65
18	0,73
19	0,81
20	0,89
21	1,00
22	1,08
23	1,19
24	1,29
25	1,38
26	1,51
28	1,76
30	1,98
32	2,29
33	2,44
35	2,79
36	2,90
38	3,23
40	3,60
42	3,95
45	4,60
50	5,50
55	6,80
60	8,05
65	9,47
70	10,70
75	12,60
80	14,20
85	16,20

Diametrs, mm	kg/m
90	18,10
95	20,20
100	22,40
105	24,70
110	27,10
115	29,60
120	32,10
125	35,00
130	37,50
140	43,80
145	47,20
150	50,10
160	57,10
165	60,90
170	64,70
175	67,30
180	72,50
190	81,30
200	89,50
210	98,70
220	108,40
240	128,90
250	136,60
260	151,40
280	175,60
300	202,00
310	215,00
320	229,00
350	274,00
360	290,00
380	323,00
400	358,00
430	414,00
450	453,00
480	515,00
500	560,00

Sakausējumi	
EN AW	6060
EN AW	6063
EN AW	6082
EN AW	6262R
EN AW	2011
EN AW	2014
EN AW	7075
EN AW	2007
EN AW	5083
EN AW	5754
EN AW	2017
EN AW	2024





## Profili WC kabīņu izgatavošanai (Pildījums 16 mm)

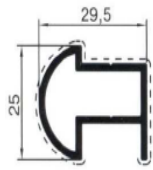

L=6000 anod Na 15

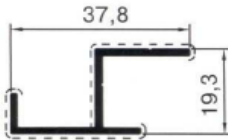

L=6000 anod Na 15

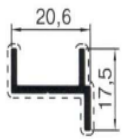

L=6000 anod Na 15

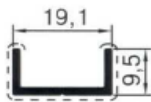

L=6000 anod Na 15

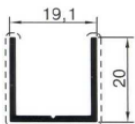

L=6000 anod Na 15

## Profili rāmīšu izgatavošanai

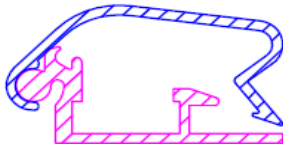

25 un 32 mm platums, komplektācijā stūrīši un atsperītes

## Profils polikarbonātam

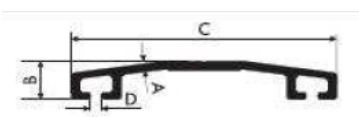

B C D

9 60 3

## Profils reklāmas gaismas kastēm

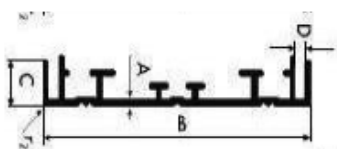

A B C D

1,8 139 20,5 6,2

## Alumīnija profili ventilējamām fasādēm

Kods	Profila skice	kg/m
L-50x40x1.8		0,41
L-180x40x3	L-profils 180x40x3, R	1,996
L-210x40x3	L-profils 210x40x3	2,279
T-60x50x1.8		0,502
T-80x50x1.8		0,589
T-100x50x1.8		0,675
T-120x50x1.8		0,764

## Transporta sistēmu alumīnija profili

TS1  
1.32 kg/m

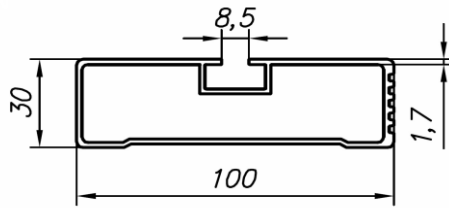

TS2  
1.541 kg/m

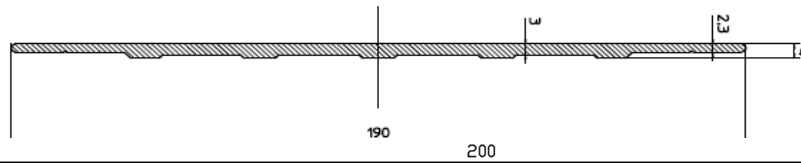

ATP202  
2.506 kg/m

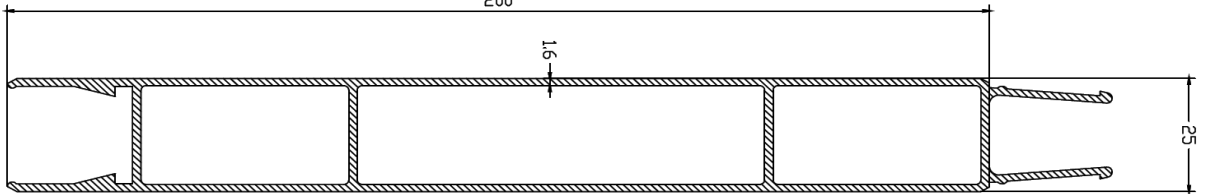

ATP203  
2.965 kg/m

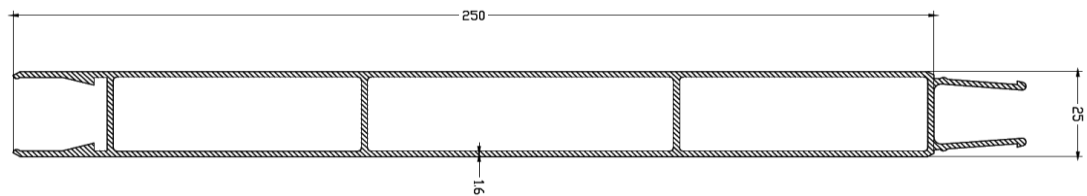

ATP200  
2.832 kg/m

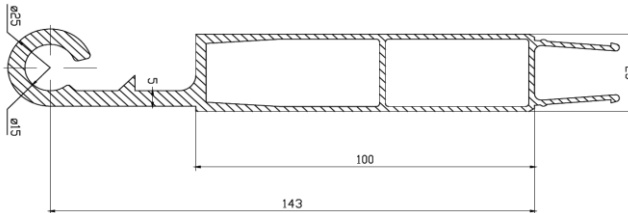

ATP204  
2.286 kg/m

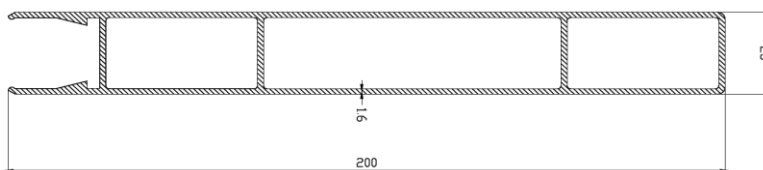

ATP201  
2.812 kg/m

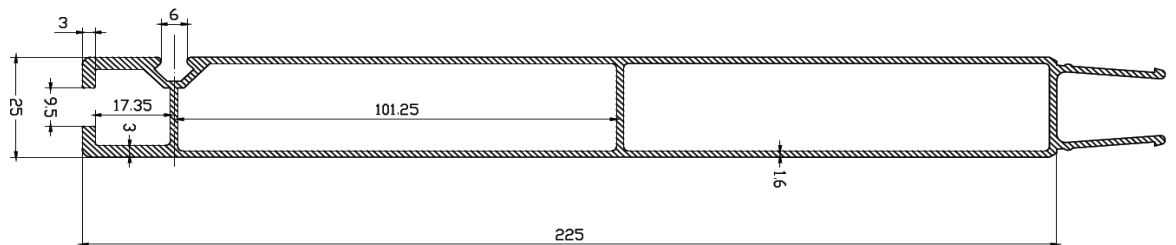

ATP100  
4.336 kg/m

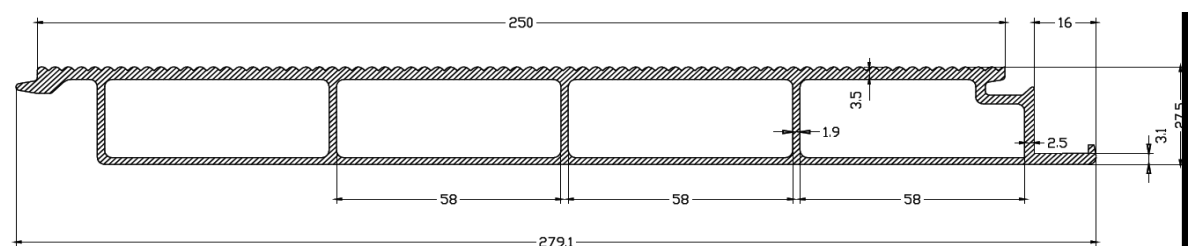

# ARTRIAL

ATP101  
5.269 kg/m

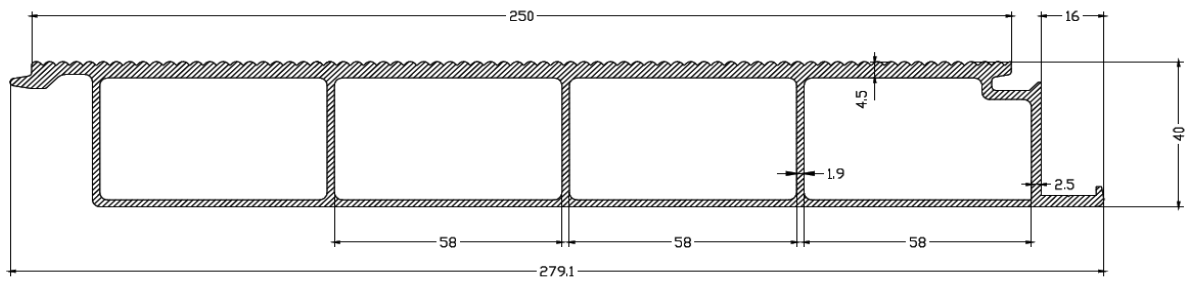

TS10  
4.537 kg/m

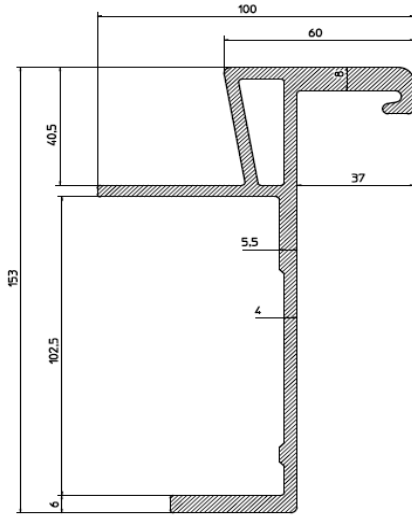

TS11  
2.427 kg/m

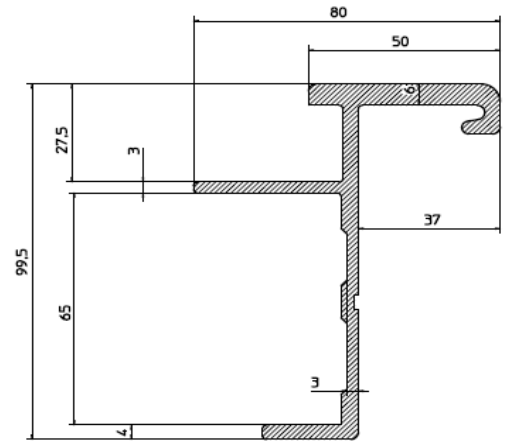

TS12  
4.516 kg/m

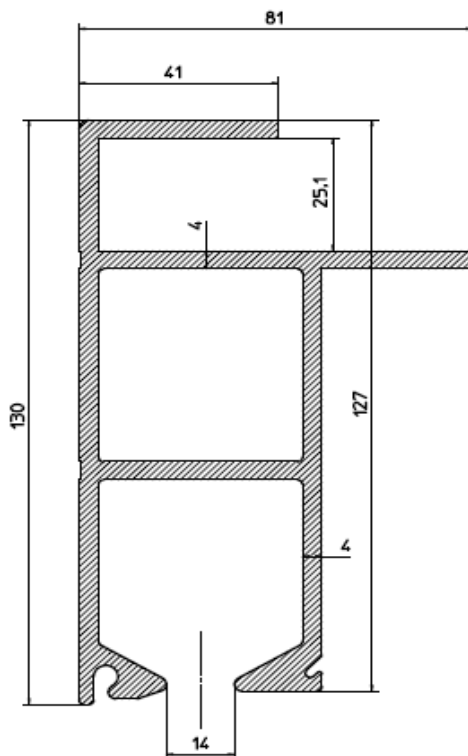

TS13  
3.517 kg/m

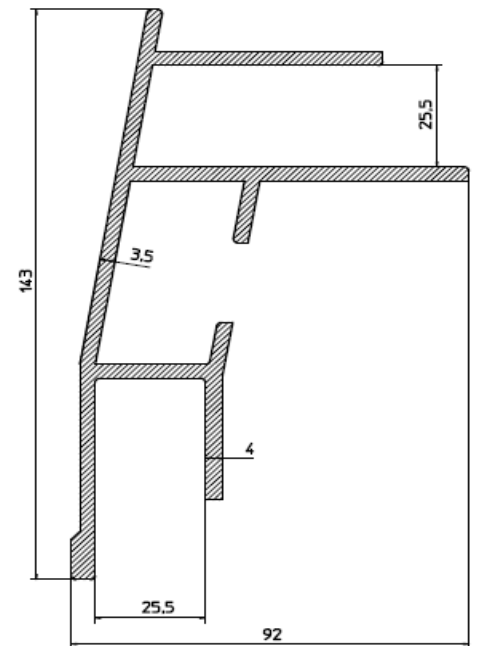



# ARTRIAL

ATP112  
8.298 kg/m

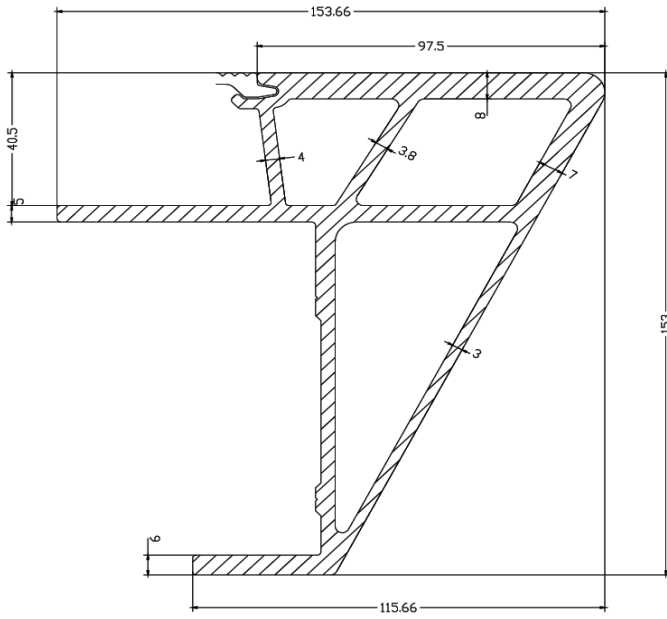

ATP140  
2.802 kg/m

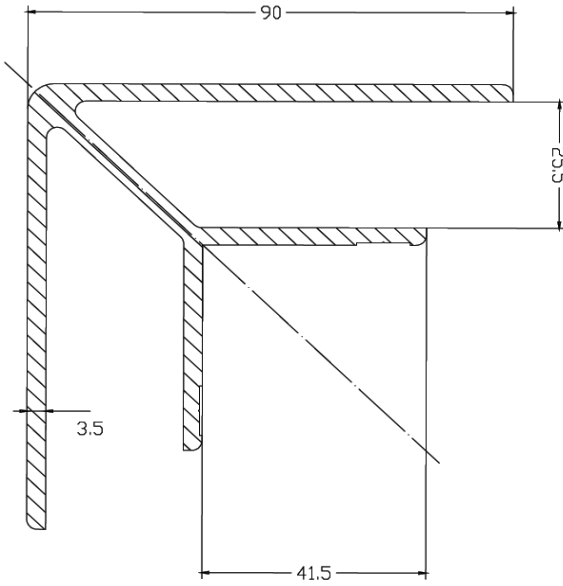

ATP135  
1.411 kg/m

