

## Transporta sistēmu alumīnija profili

TS1  
1.32 kg/m

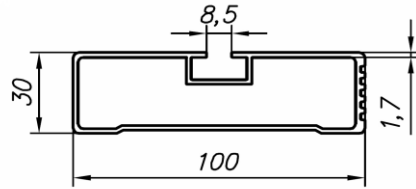

TS2  
1.541 kg/m

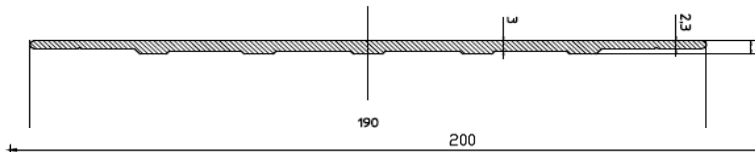

ATP202  
2.506 kg/m

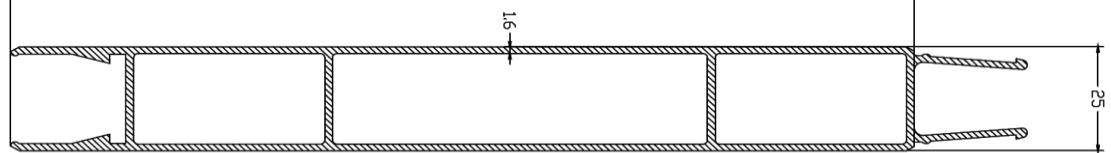

ATP203  
2.965 kg/m

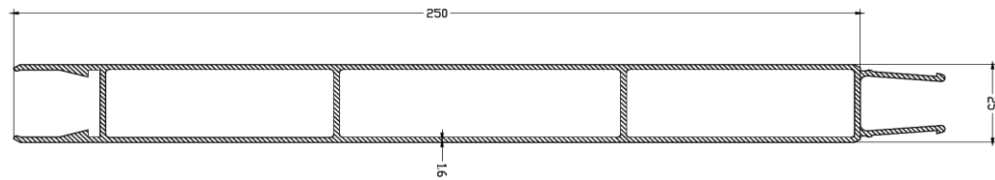

ATP200  
2.832 kg/m

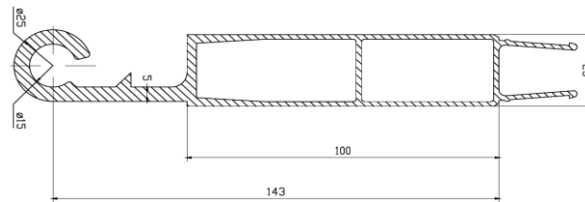

ATP204  
2.286 kg/m

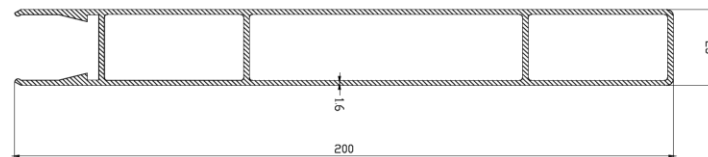

ATP201  
2.812 kg/m

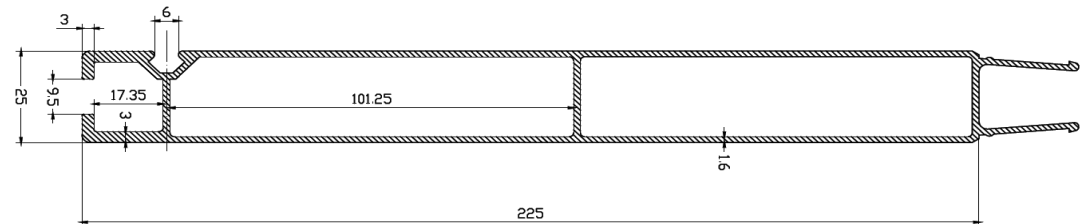

ATP100  
4.336 kg/m

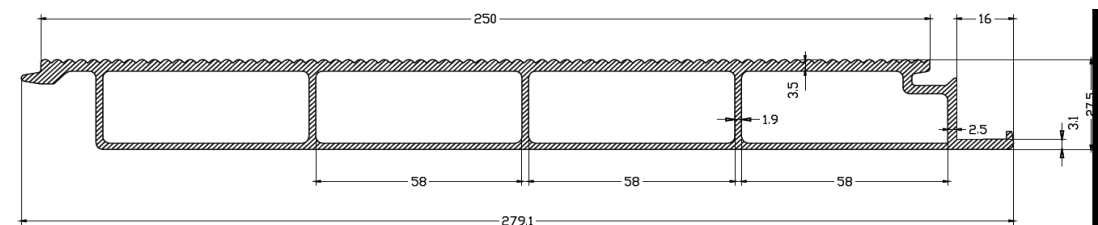

# ARTRIAL

ATP101  
5.269 kg/m

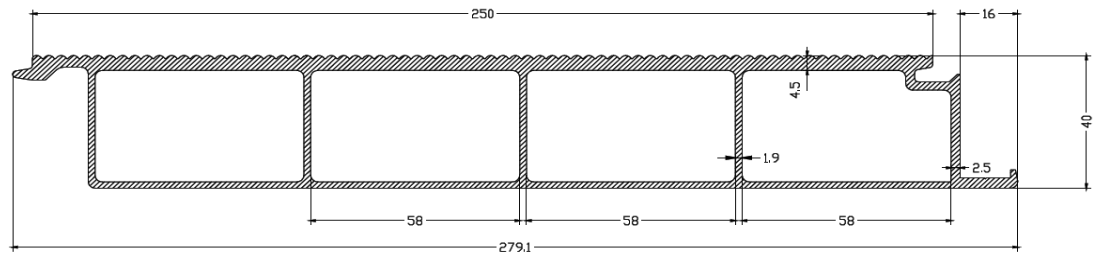

TS10  
4.537 kg/m

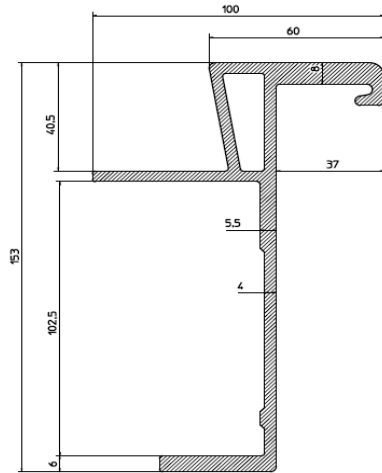

TS11  
2.427 kg/m

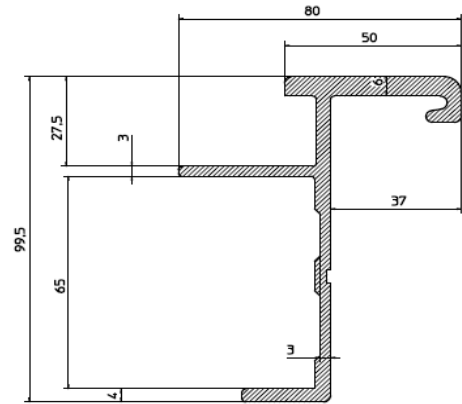

TS12  
4.516 kg/m

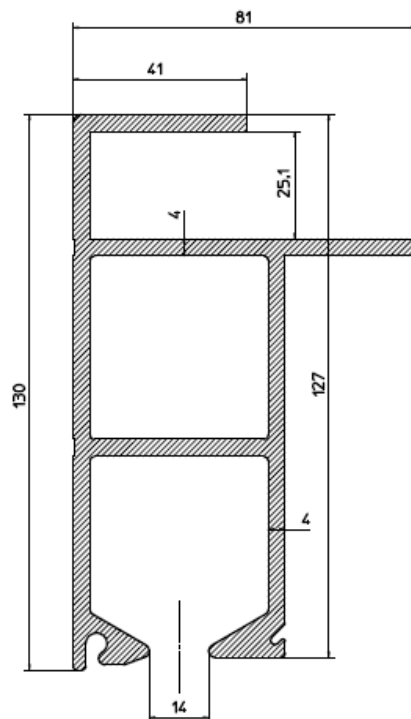

TS13  
3.517 kg/m

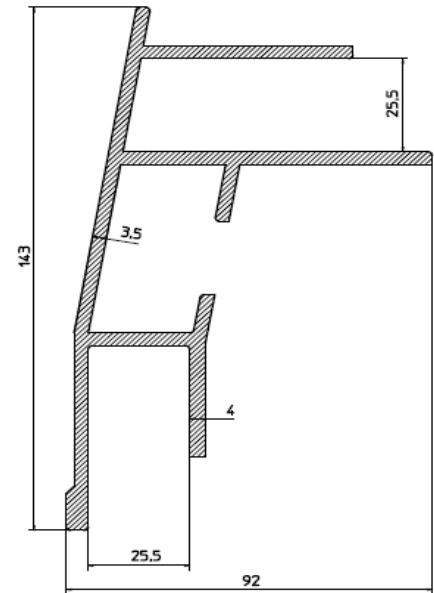

ATP112  
8.298 kg/m

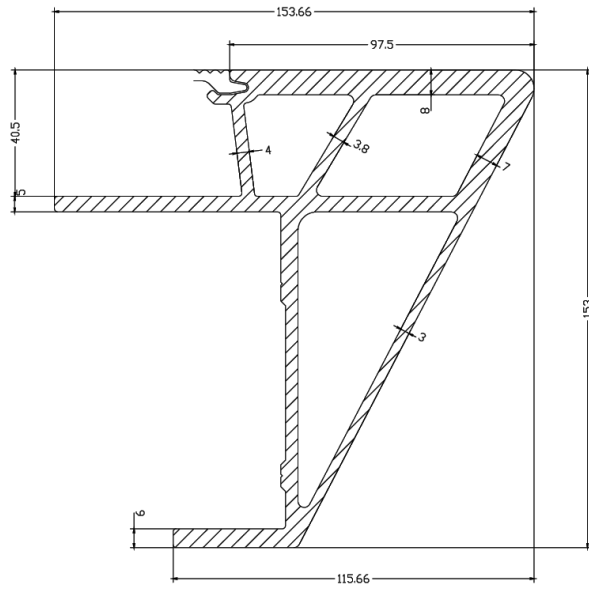

ATP140  
2.802 kg/m

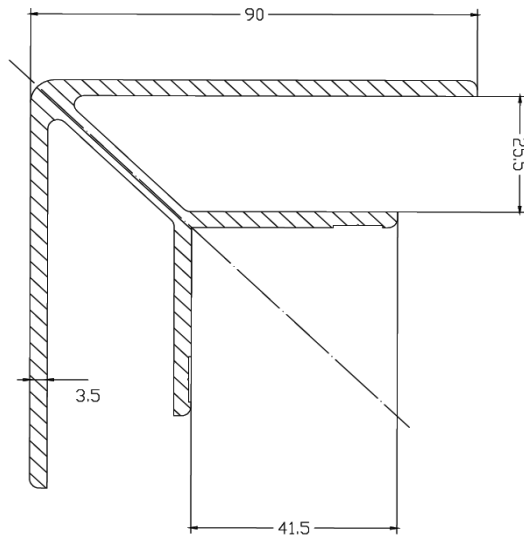

ATP135  
1.411 kg/m

